



INSTALLATION GUIDE

# ALL IN ONE + GIV-GATEWAY

---

 13.5kWh | UK V2.0

## Introduction

All information contained in this booklet refers to the installation and maintenance of GivEnergy's All in One and Giv-Gateway. Please retain this manual for future reference.

**Legal Disclaimer:** This document is the property of GivEnergy, reproduction is prohibited.

## Installation Requirements

Installation of the GivEnergy All in One and Giv-Gateway must be carried out by a **GivEnergy Approved Installer** and in accordance with the IEE Wiring Regulations.

## Unit Information

The All in One contains a bidirectional inverter and a 13.5kWh lithium iron phosphate battery. Used with our Gateway, the system can provide whole home backup when a power outage occurs. The system can charge from the grid when prices are cheaper, and export stored generation when prices are at their peak. The Giv-Gateway interface features a display for a PV inverter, EV charger, grid and home storage battery.

## Storing the All in One and Giv-Gateway

The unit must be stored in its original packaging at temperatures between -40°C - 70°C. Do not stack more than 4 units on top of each other.

## Packaging Contents

When unpacking, please check the following:

- ✔ There are no missing accessories from the packaging list
- ✔ The model and specification of the All in One and Giv-Gateway's nameplate match the order specifications
- ✔ Ensure the packaging and product are free from any damage

If any damaged or missing parts are found, please contact Enga on email

**info@en-ga.com** immediately. Returns must be provided in the original or equivalent packaging. The gateway's cardboard packaging is recyclable.

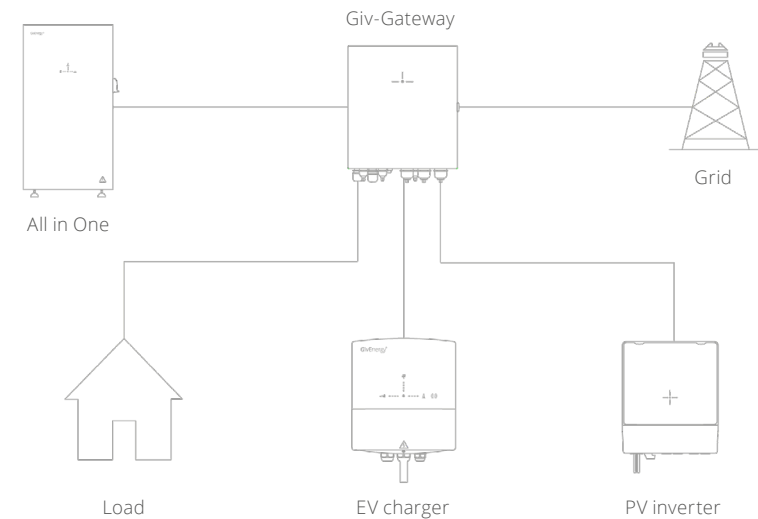



**ROBUST AND FLEXIBLE**  
A great addition to any smart home

Primarily working as an on grid system, the All in One can deliver 7.2kW of peak power into the home on top of any solar generation.

Complete with a substantial 13.5kWh useable battery pack that stores excess generation. Connect up to 6 systems in parallel, giving 80kWh of useable storage (coming soon). Featuring a modular design comprising 4 removable battery packs, allowing for ease of handling and installation.

Specifications

**Dimensions**  
1100H x 280D x 600W (mm)

**Weight**  
173.7 Kg

**AC Input Rating**  
6000W

**AC Output Rating**  
7.2kW / 32 A Peak  
6.0kW / 26A Continuous

**Noise Emission (typical)**  
<30dB

**Operating temperature**  
-10°C to 50°C

**Depth of Discharge**  
100%

**Connectivity**  
WiFi, LAN and 4G

**Warranty**  
12 years

Item	Item Name	Qty
A	All in One Unit	1
B	Bracket	2
C	Expansion Bolt	4
D	WiFi Antenna	1
E	Spirit Level	1

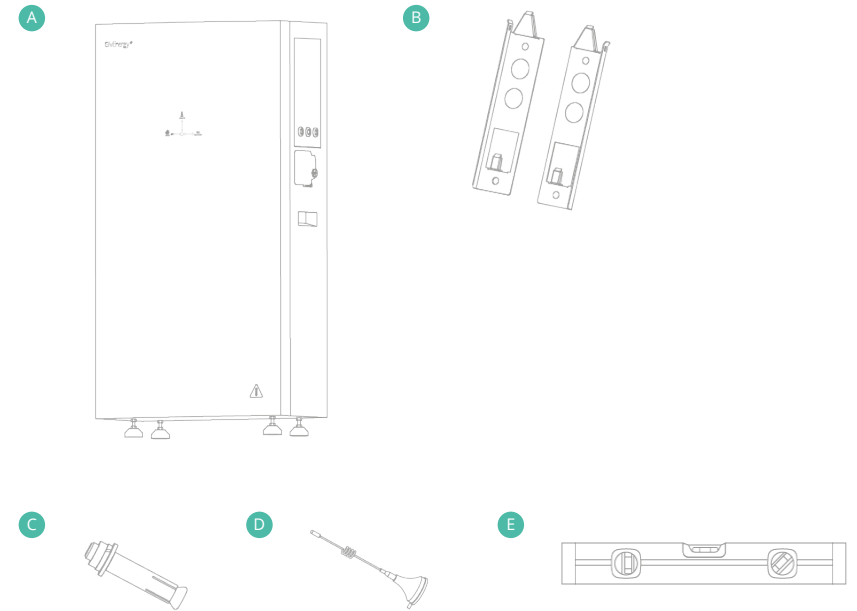

## ALL IN ONE COMPONENTS

Item	Item Name
A	Power Flow Indicator
B	AC Supply Terminals
C	Wifi Antenna
D	DC Circuit breaker
E	On / Off Switch
F	Cable entry point

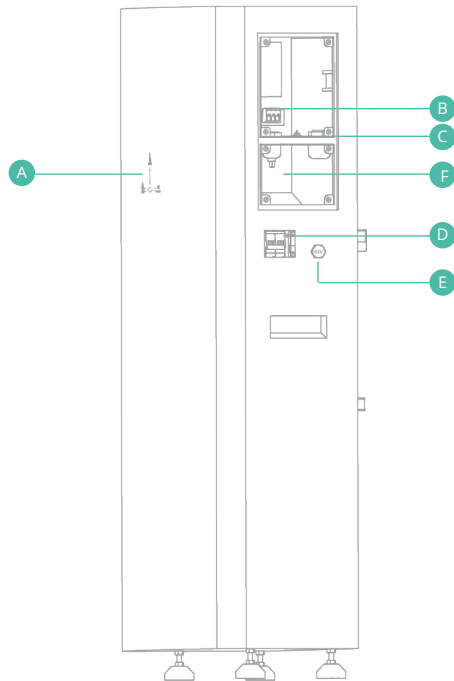

## ALL IN ONE UNBOXING

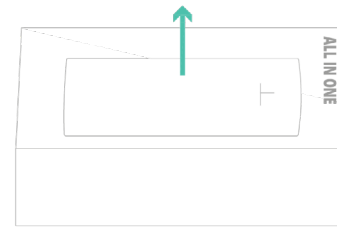

1. Remove top cover from the wooden crate

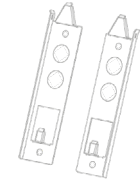

2. Remove the All in One brackets and place to one side

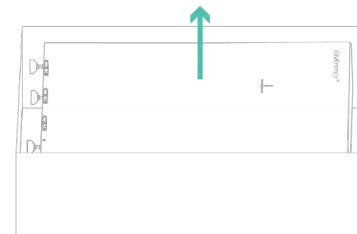

3. Remove front cover of the All in One

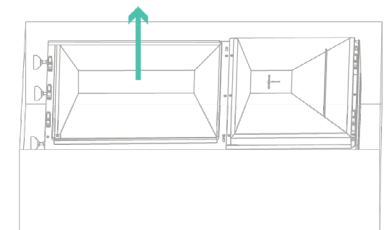

4. Remove bottom waterproof cover of the All in One

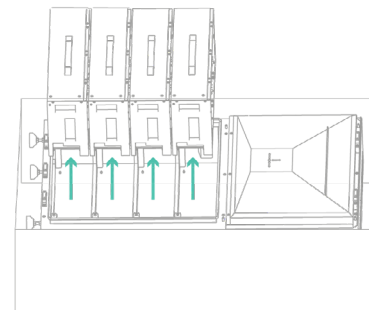

5. Remove the battery packs, leave to one side

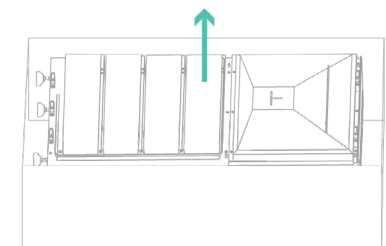

6. Remove All in One case from wooden crate (2 person lift)

## INSTALLATION INSTRUCTIONS



The system must be installed in an easily accessible location, the status display must be visible and not obstructed



Please ensure that the wall to be mounted on is sufficient enough to hold the weight of the All in One and Giv-Gateway



The system must be installed in a well ventilated area, the ambient temperature should be below 40°C to ensure optimal operation



The system must be installed vertically with connections always positioned at the bottom, never install horizontally, and avoid tilting the unit



The system must be installed under a canopy if installing externally



The feet of the All in One are designed to be above the frost-line at a minimum of 50mm



Do not install in direct sunlight or near water sources



Do not use the equipment if there are any deformities, such as bulging or leakages



Do not puncture the equipment



Do not throw the equipment or use forceful impact



Do not attempt to repair the equipment yourself (please call your Approved Installer)

## SAFETY INSTRUCTIONS

Extra care and attention must be taken when installing and maintaining any GivEnergy equipment. The system is capable of retaining a high voltage, even when disconnected.

- If you suspect something is wrong with the system, contact GivEnergy on **01377 252 874** or email **support@givenergy.co.uk**
- If any damaged or missing parts are found, please contact GivEnergy on **01377 252 874** or email **support@givenergy.co.uk** immediately. Returns must be provided in original or equivalent packaging
- All electrical installations must be carried out by a qualified and registered Electrician and in accordance with the IEE Wiring Regulations
- During operation, the heat sink may become hot. Do not touch the heat sink at the sides, or the top of the inverter when in operation
- The system is designed to be connected to the grid; connecting your inverter to a generator or other power source can result in damage to the inverter or external devices
- All GivEnergy equipment must be installed by a GivEnergy Approved Installer
- Ensure all components are attached securely
- Ensure the All in One and Giv-Gateway are always fixed to the wall using the mounting bracket

# ALL IN ONE STEP-BY-STEP INSTALLATION

1. Place the wall mounting bracket horizontally onto the wall and mark the position of the bracket holes. Drill 4 holes at the marked positions, at least 75mm deep.

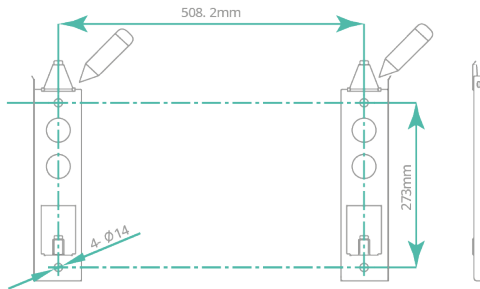

2. Fix the mounting bracket to the wall using the expansion bolts. Please note: the brackets are sided.

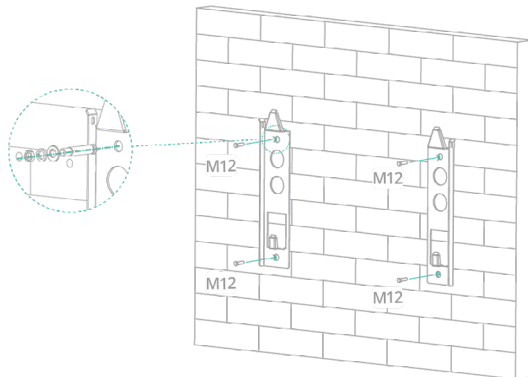

3. Mount the All in One onto the mounting bracket. Adjust the height of the supporting feet to ensure the unit is level and attach the securing screws to the brackets, ensuring the weight is on the feet, not the brackets. Brackets are there for stability.

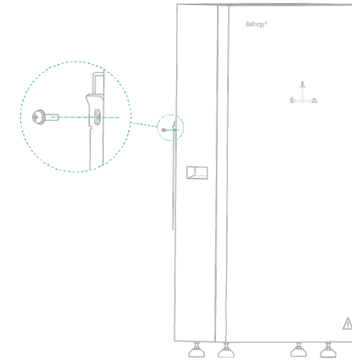

4. Re-insert the battery modules into the shelves of the All in One battery compartment. Secure the battery modules using the fixings provided. Re-attach waterproof cover.

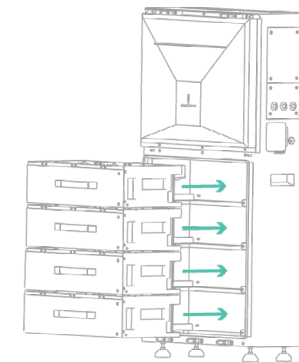

5. Replace the front cover and secure with the screws.

# CLEARANCE AND MAINTENANCE

## Space Clearance

There must be adequate clearance around the All in One to allow for heat dissipation. The diagram below illustrates the space required around the system.



## Maintenance

When maintaining and cleaning the All in One, **the whole system must be powered down**. Please refrain from using cleaning products on the surface of the All in One.

To ensure your All in One operates optimally at all times, annual maintenance checks need to be carried out. Check for visible damage or discolouration of the switch, and that the cables are intact. Please ensure that the top of the All in One is not obstructed in any way.

# ALL IN ONE CONNECTIONS OVERVIEW

Item	Item Name
A	Communication / network ports
B	AC Supply

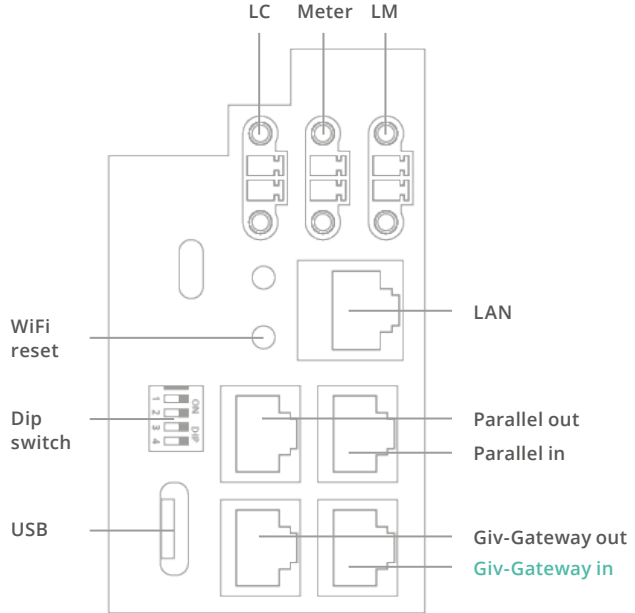
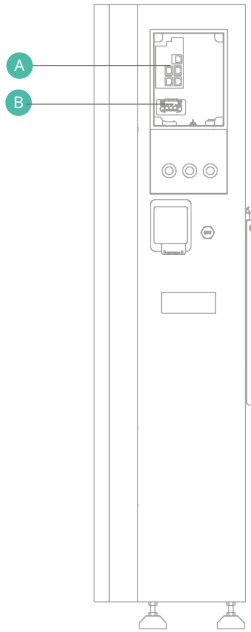

All in One communication / network ports

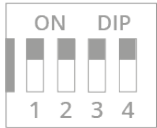

WiFi

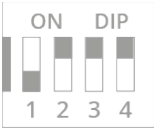

LAN



USB (Dongle) Mode

## ALL IN ONE AC UTILITY GRID CONNECTION

Cable size requirements for the All in One are 6mm<sup>2</sup> minimum.

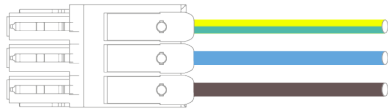

Both side and rear cable entry points are provided. If using rear entry point please ensure the cable is installed prior to fitting the All in One. The AC supply cable should enter through one of the waterproof glands and pass through the cable entry chamber (labelled below) and connected into the AC supply terminal block. The supply cable should be at least 6mm<sup>2</sup>. Strip the outer insulation to 8mm in length of bare copper and connect them to the terminal block.

The recommended maximum cable length should not exceed 50m as the resistance of the cable will consume inverter output power and reduce the inverter efficiency.

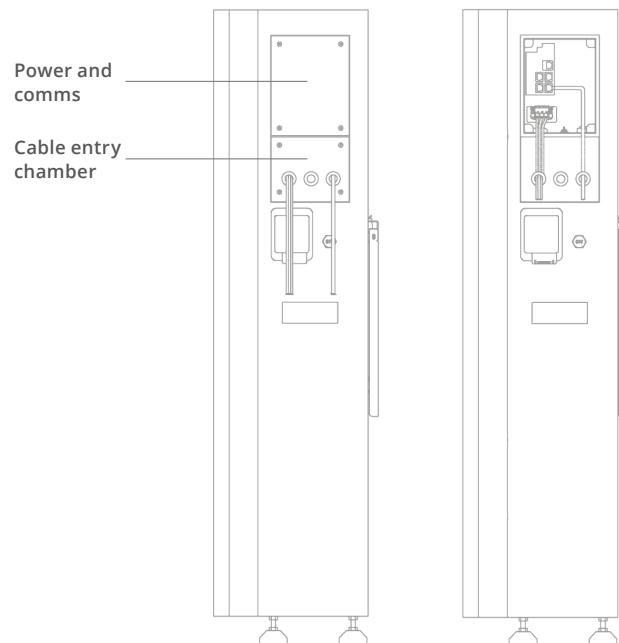

## ALL IN ONE COMMUNICATION WIRES CONNECTION

### Single All in One installation

To install a single All in One, connect communication wire to the **socket D** in the wiring compartment of the All in One.

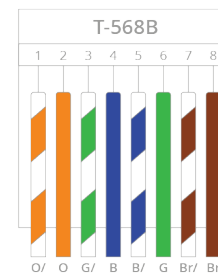
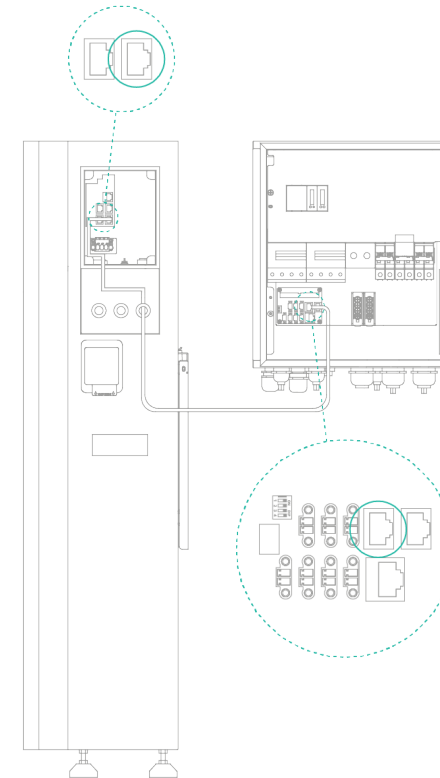

**Please note:** The communication cable must be terminated with a RJ45 plug at either end to connect the All in One to the Giv-Gateway. Ensure the wiring configuration into the RJ45 is the same both ends, a cross-over cable will not work. A standard Ethernet Cat5/6 cable will suffice here wired to T-568B standard if doing locally.





**WHOLE HOME BACKUP**

A great companion to the AIO

By purchasing the additional Giv-Gateway, the All in One can provide whole house backup in the event of a grid failure.

The Giv-Gateway provides seamless switching between grid and battery ensuring that your property is always powered. The Giv-Gateway also facilitates a connection point for your solar PV system by allowing it to continue to generate energy even without a grid supply.

**Specifications**

**Dimensions**  
410H x 190D x 370W (mm)

**Weight**  
12.75 Kg

**Nominal AC Power**  
18.4 kW

**Rated Grid Frequency**  
50/60±5Hz

**Protection Class**  
IP65

**Max. AC Current**  
100A

**Warranty**  
12 years

Item	Item Name	Qty
A	Giv-Gateway	1
B	Bracket	1
C	Mounting screw	2
D	Wall plug	2
E	Antenna	1
F	Key	1
G	M6 x 12 Bracket Screw	4

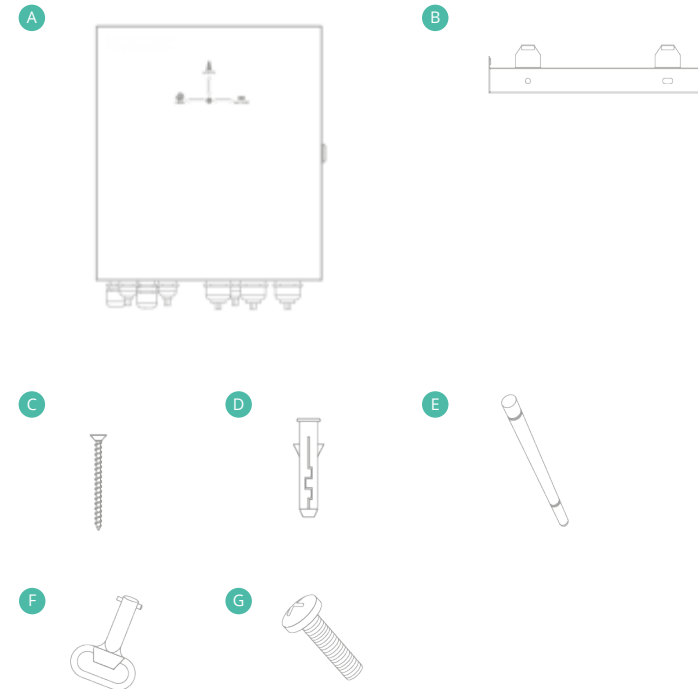

## ISOLATING THE MAIN SUPPLY TO THE PROPERTY

Before installing the Giv-Gateway, make sure that the whole house is isolated from the main supply.

Once isolated, please test to ensure that no voltage is present to the property before disconnecting the main supply cable from the consumer unit. The Giv-Gateway should be installed between the customer's supply meter and the consumer unit.

## GATEWAY COMPONENTS

Item	Item Name
A	MCB, RCD
B	Grid / PV Meter and LoRa (spare)
C	CT, RS485, LAN, CAN, DRM

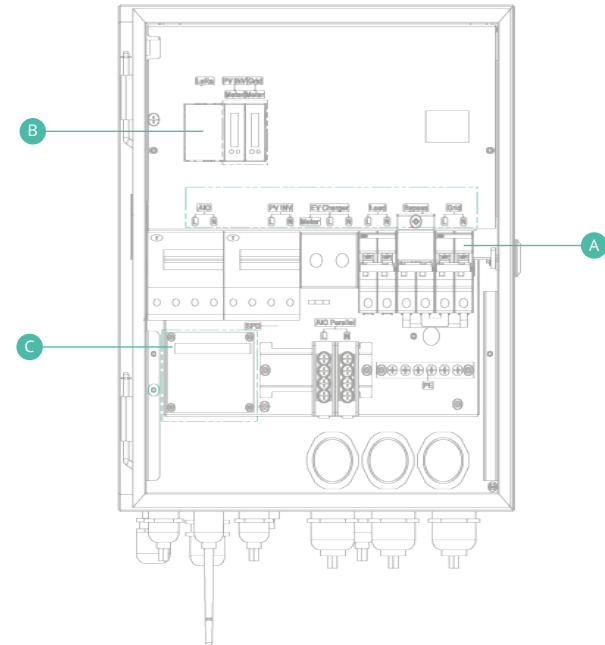

## GATEWAY STEP-BY-STEP INSTALLATION

1. Place the wall mounting bracket horizontally onto the wall and mark the position of the bracket holes. Drill 2 holes at the marked positions, at least 75mm deep.

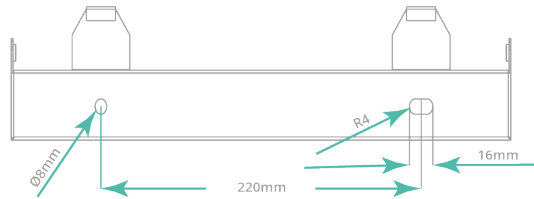

2. Fix the mounting bracket to the wall using the fixings provided, or other suitable fixings.

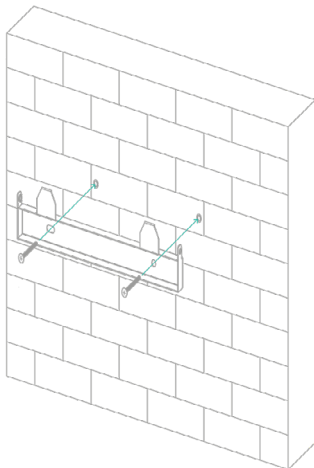

3. Fix the Gateway to the mounting bracket and secure with the fixings provided. Ensure there is adequate clearance space.

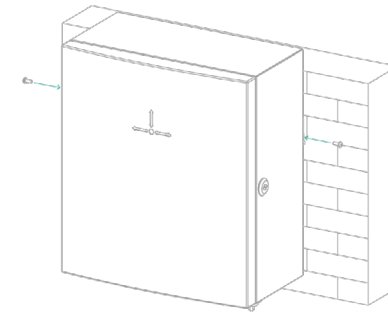

## Space Clearance

There must be adequate clearance around the Giv-Gateway. The diagram below illustrates the space required around the system.

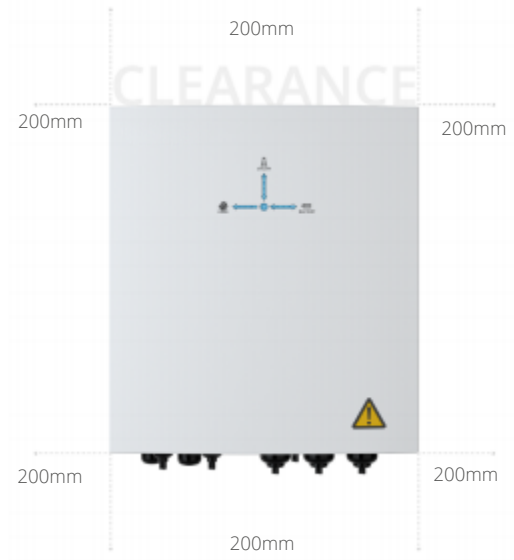

## Maintenance

When maintaining and cleaning the Giv-Gateway, please refrain from using cleaning products on its surface.

To ensure your Giv-Gateway operates optimally at all times, annual maintenance checks need to be carried out. Check for visible damage or discolouration of the switches, and that the cables are intact. Please ensure that the top of the Giv-Gateway is not obstructed in any way.

## Item

## Item Name

A	LoRa connection Module (spare)
B	PV meter (ID2)
C	Grid meter (ID1)
D	Load (house supply)
E	AC supply (in)
F	All in One supply
G	PV inverter supply
H	EV charger (spare)
I	All in One parallel connection (coming soon)
J	Grid bypass switch

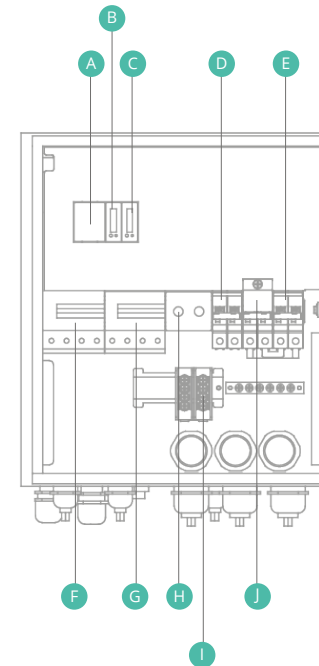

## GIV-GATEWAY AC UTILITY GRID CONNECTION

### Breaker A - Single All in One connection

The power wires for All in One connection should be at least 6mm<sup>2</sup>. Strip the wire insulation for 8mm wiring connection.

### Breaker B - PV inverter connection

### Breaker C - EV charger connection

The maximum load current is 32A, so the load wires should be at least 6mm<sup>2</sup>. Strip the wire insulation for 8mm for wire connection.

### Breaker D - Loads connection

The maximum load current is 80A, so the load wires should be at least 16mm<sup>2</sup>. Strip the wire insulation for 8mm to connect to this load breaker.

### Breaker E - Bypass MCB

The bypass switch redirects grid power directly to the house, bypassing the Giv-Gateway.

### Breaker F - Grid connection

The maximum load current is 100A, so the load wires should be at least 16mm<sup>2</sup>. Strip the wire insulation for 8mm to connect to this load breaker.

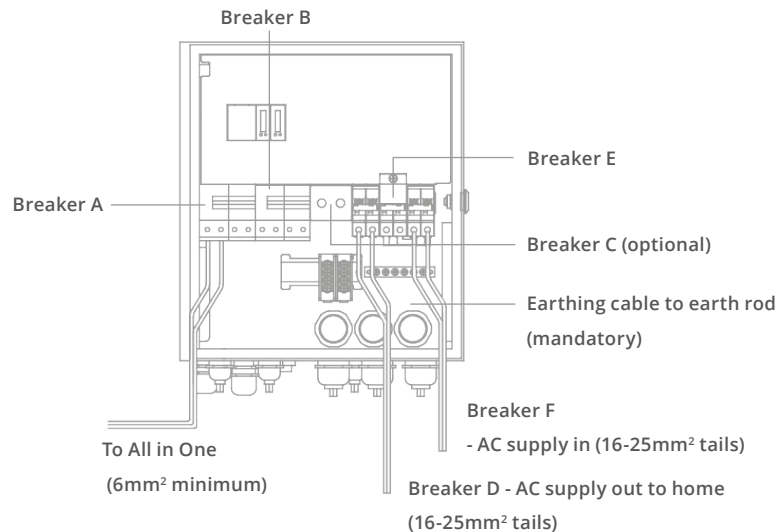

## GIV-GATEWAY COMMUNICATION CONNECTIONS

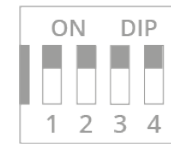

WiFi



LAN



USB (Dongle) Mode

### Gateway communication/network ports

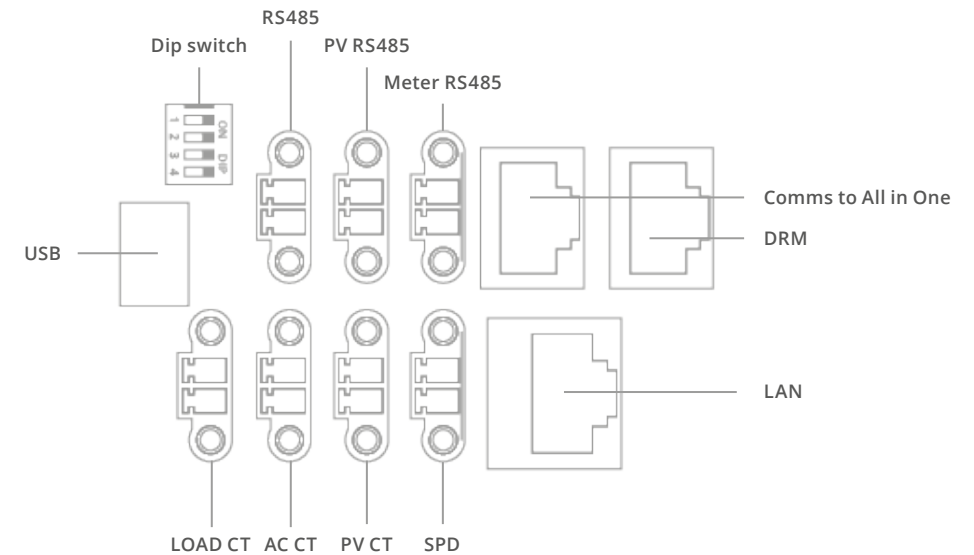

The meter tails between the meter position and Givenergy Gateway should not be longer than 3 metres. If the length is more than 3 metres, you should install an additional protective device at the nearest point to the supply inside the customer's premises, as specified in the current IEE Wiring Regulations.

## CONNECTING ALL IN ONE TO GATEWAY

Please note: Remove bottom connections cover prior to wiring, and then replace once complete.

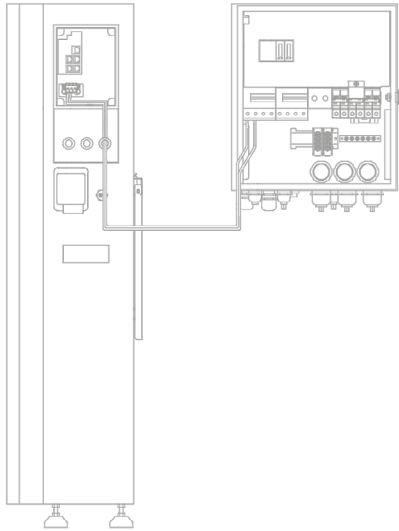

AC supply wiring

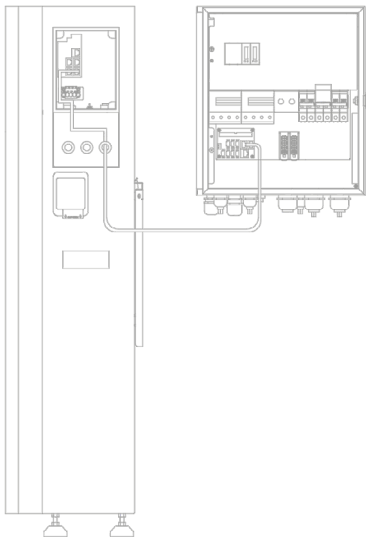

Communication wiring

## START-UP AND SHUT-DOWN OF THE ALL IN ONE

### Start-Up Procedure

1. Ensure connection covers are in place
2. Connect the AC circuit breaker, ensure that the system is powered and commissioned using the portal/App. Ensure that the grid power is reading identical to that of the mid approved meter (this can be found on the screen of the grid meter)
3. Turn on the battery breaker (DC MCB)
4. Turn on the battery (On/Off switch)
5. The inverter will start automatically when the battery voltage is higher than 270V DC or the Giv-Gateway provides AC voltage to the All in One  
Please note: House load will not be present unless the All in One is online, or BYPASS breaker is activated. **BYPASS must not be kept on.**

### Shutdown Procedure

1. Turn off the battery (On/Off switch)
2. Turn off the battery breaker to prevent it from being reactivated (DC MCB)
3. Turn off the AC circuit breaker to prevent it from being reactivated (AIO MCB)
4. Check the inverter operating status
5. Wait until all LEDs have gone out. The All in One is now shut down

## COMMISSIONING A SYSTEM

All systems must be commissioned to ensure correct battery and meter communications, as well as connection to the online portal.

**Note:** Without commissioning, the system may not operate correctly.

Check that all the wires are securely connected before the battery breaker and the AC isolator is switched on. You MUST set the parameters of the battery according to your battery system.

### Accessing the Commissioning Portal

Sign into the online portal at <https://portal.givenergy.cloud> with your GivEnergy Engineer login. If you are a first time user, and you do not have an account or Engineer login, please consult your supplier to get this set up.

➤ To download a fully illustrated guide, please visit our Knowledge Base at [www.givenergy.co.uk](http://www.givenergy.co.uk)

## EXAMPLE DEFAULT WIRING CONFIGURATION

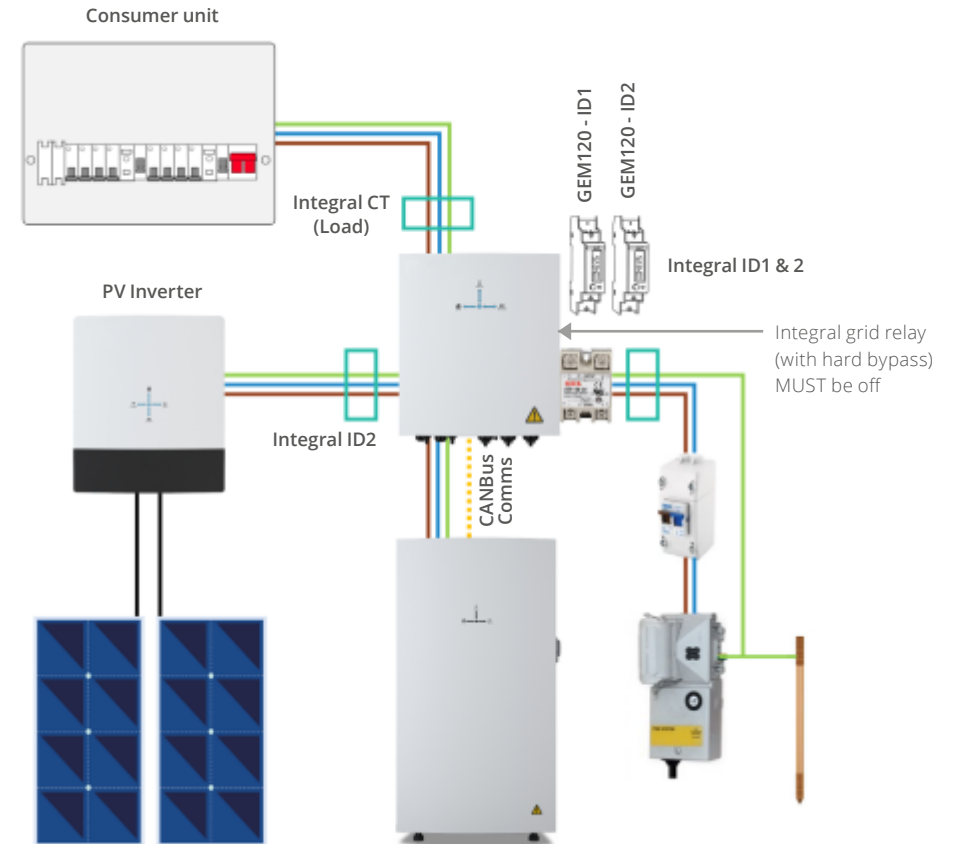

Note: An earthing rod **MUST** be installed.

## WORK MODES



### Off Peak Charging

This is prioritised to charge the battery during off peak times when energy is cheaper, greener, and cleaner. The battery will start to discharge outside of the off peak time when energy is more expensive.



### Solar Charging

This is prioritised to charge the battery utilising excess solar generation, when energy is cheaper, greener, and cleaner. The battery will start to discharge outside of the peak generating hours when energy is more expensive.



### Back Up / Island Mode

The system has the ability to be used in the event of a power cut. To utilise this the All in One must be connected to a Giv-Gateway. In the event of a power cut the Giv-Gateway will seamlessly switch over to battery to power the whole home.



### Off Grid Operation

Remotely disconnect your home from the grid at the push of a button using the **GivEnergy App or Online Monitoring Portal**.

## MANUFACTURER WARRANTIES

This All in One and Giv-Gateway are covered by 12-year warranties.

### Products Covered



**All in One 13.5**  
10 years



**Gateway**  
10 years





[www.en-ga.com](http://www.en-ga.com)